

SmartX IS COMPACT AND INTEGRATED

- INTEGRATED LASER
- INTEGRATED SAMPLE STAGE
- INTEGRATED VIBRATION ISOLATION
- INTEGRATED ELECTRONICS
- INTEGRATED PC AND SOFTWARE
- INTEGRATED ISOLATION CAGE

SmartX IS MODULAR AND VERSATILE

- ACUTE AND ORGANOTYPIC TISSUE SLICES (Upright)
- ORGANOIDS, SPHEROIDS, METABOLOMICS (Inverted)
- INTRAVITAL IMAGING (Inverted)
- MOUSE BEHAVIOR EXPERIMENTS WITH VR (Upright)
- ZEBRAFISH, DROSOPHILA (Upright)
- HIGH THROUGHPUT RESEARCH FOR HEALTHCARE

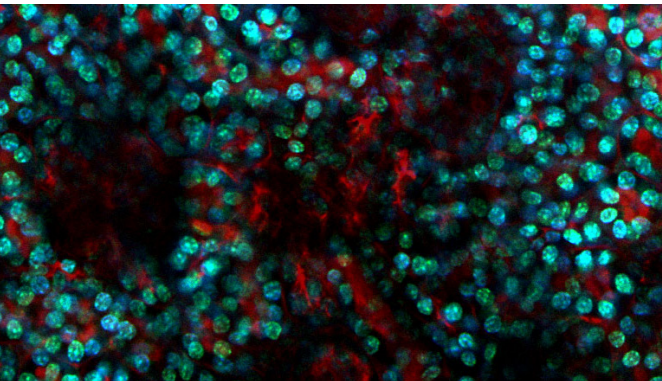

KEY SPECIFICATIONS*

MODEL: Inverted or upright configuration

LASER SCANNING: Laser scanning with galvanoscanners, resonant scanner or dual configuration

LASER SOURCE: Integrated 920 nm or 1040 nm mode locked laser source, <100 fs

OBSERVATION CAMERA: Wide field of view CMOS camera for brightfield and epifluorescence modes, 20MP, 17fps

OBSERVATION MODES: two-photon, green illumination and epifluorescence, transmitted nIR

FOCUSING: Motorized focus with 30mm range of movement, zero drift design. Optional piezo for fast volume scanning

OBJECTIVE: Water immersion physiology objective with high NA, large WD. M25x0.75 or M32x0.75 threads, up to 95 mm PFL

DETECTORS: High efficiency 2" detection light path, up to 3 high sensitivity GaAsP detectors

MOTORIZED SAMPLE STAGE: 80x130 mm movement range
Compatible with K-frame stage inserts

CAGE: Ergonomic opening of sample compartment, electrically shielded, light and airtight

CONTROL UNIT: Measurement control electronics, 2x analog IO, 4x digital IO. 3-axis handwheel unit for focus and stage control
Built-in high-performance PC to support measurement control and analysis, 2 x 27" monitors

SOFTWARE: MESc: State-of-the-art measurement control software, HDF5 based file storage, API automation

DIMENSIONS: 750 x 950 x 1550 mm (L x W x H)
Recommended space 2 x 2 m including desk for control

**Preliminary specification, subject to change*

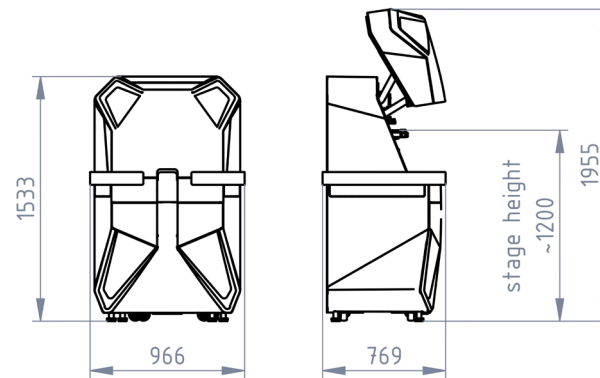

SmartX TWO-PHOTON MICROSCOPE

» TURNKEY

» COMPACT

» MODULAR

» AFFORDABLE

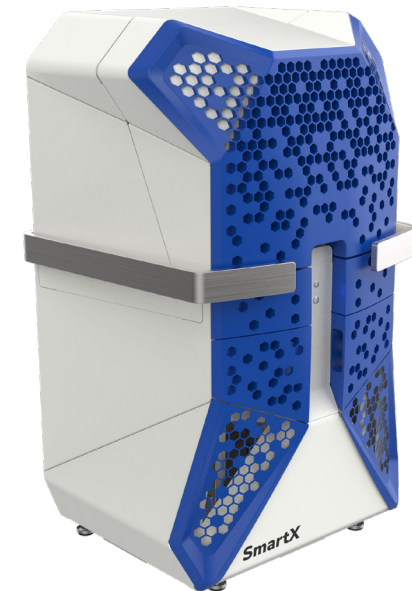

COMPACT MODULAR TWO-PHOTON
MICROSCOPE FAMILY FOR VERSATILE
BIOIMAGING APPLICATIONS

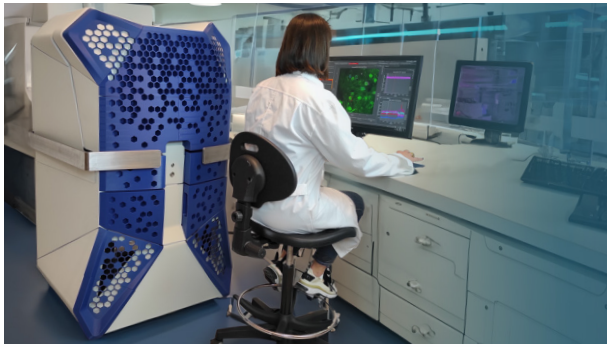

THE „PLUG AND PLAY” (PNP) CONCEPT

Two-photon technology is thought to be challenging. Putting together the dedicated environment, the range of specialized equipment, and the in-depth technical expertise requires a lot of time and resources.

You can now build a two-photon lab quickly, easily, and affordably with **FEMTONICS' NEW SmartX PNP MICROSCOPE SERIES!**

The equipment **integrates everything you need to get the imaging up and running**, so you will be ready to go in any laboratory room in a matter of hours. In case you need to relocate the instrument, it simply rolls on rubber wheels.

SmartX INVERTED PNP

For rodent intravital imaging and 3D cellular models (e.g. organoids and spheroids grown from tumor, intestinal or brain cells, organ explants or complex cellular co-cultures.)

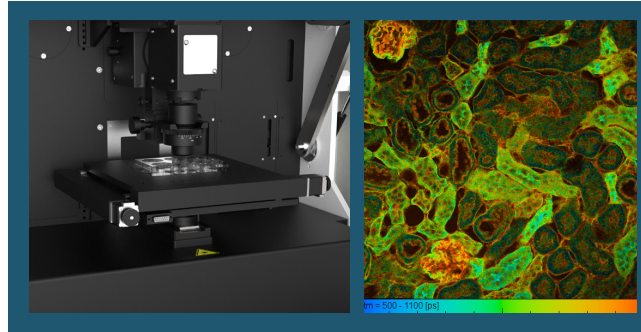

Two-photon imaging with high NA objectives enable deep tissue imaging of living samples, making it optimal to study both morphology and function.

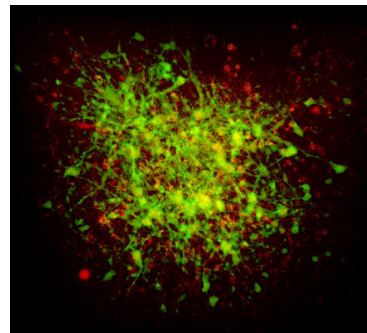

Two-photon volume imaging of an organoid sample

Image courtesy of Tatsuya Osaki, lab of Mriganka Sur, Picower Institute for learning and memory

UPRIGHT – IN VITRO

Transmitted illumination pathway, space for perfusion chamber and patch electrodes

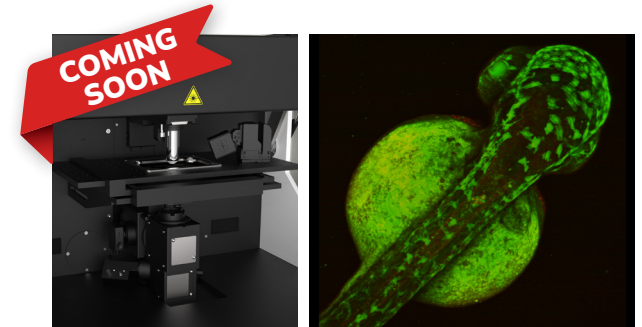

UPRIGHT – BEHAVIOR

Mouse and other small animal research, resonant scanner, space for VR system

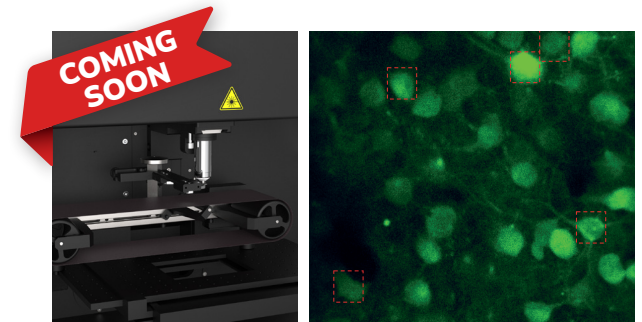

FEATURES AND OPTIONS

- High-performance galvanometer scanner for large FOV, high-resolution deep tissue investigations
- Epifluorescent illumination option, up to 3 wavelengths
- Transmitted lightpath option with nIR LED illumination for DIC imaging, FLIM detection option for metabolic imaging and various biophysical applications
- Compatible with environment control devices

FEATURES AND OPTIONS

- Resonant scanner for full-field high-speed imaging combined with simultaneous photostimulation
- Economic optogenetics with LED-based full-field illumination
- Optional transmitted IR detector during two-photon scanning
- API for advanced measurement control

